

Description	Drive Compatibility
-------------	---------------------

The MC1XAZ02 mounting card is designed to host a μ Z-style AZ series analog servo drive. This mounting card offers convenient screw-terminal connectors. Easily accessible test points are available for I/O monitoring. The MC1XAZ02 can be screw-mounted directly to a PCB when assembled with a μ Z-style AZ drive, and is ideal for both prototyping and production. The mounting card also features a keyed connector to prevent misaligned connections.

μ Z-style AZ
40 V Models
 10A

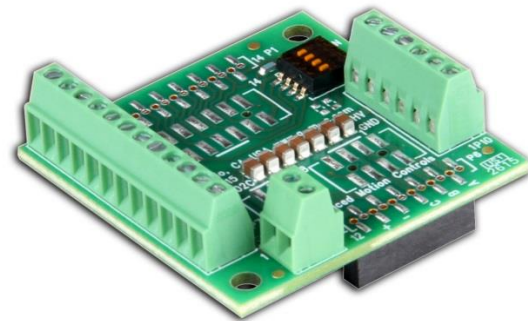

Features	
----------	--

- | | |
|---|--|
| <ul style="list-style-type: none"> ▲ Detachable Connections ▲ Lightweight | <ul style="list-style-type: none"> ▲ Small Footprint ▲ Keyed Connector |
|---|--|

DRIVES SUPPORTED

- AZB10A4
- AZBH10A4
- AZBD10A4
- AZBDC10A4
- AZBE10A4

FEEDBACK SUPPORTED

- Hall Sensors
- Incremental Encoder

COMPLIANCES & AGENCY APPROVALS

- RoHS II
- UL / cUL Pending
- CE Pending

SPECIFICATIONS

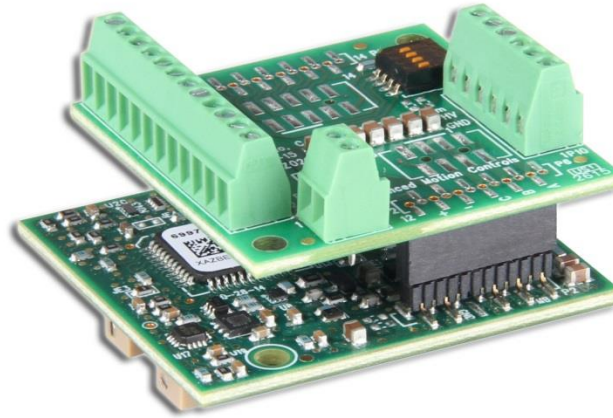

Mechanical Specifications

Description	Units	Value
Agency Approvals	-	RoHS II, UL / cUL Pending, CE Pending
Size (H x W x D) (mounting card only)	mm (in)	38.1 x 38.1 x 16.2 (1.5 x 1.5 x 0.64)
Size (H x W x D) (with current mode drive installed)	mm (in)	38.1 x 38.1 x 23.6 (1.5 x 1.5 x 0.93)
Size (H x W x D) (with velocity or duty cycle mode drive installed)	mm (in)	38.1 x 38.1 x 25.5 (1.5 x 1.5 x 1.0)
Weight (mounting card only)	g (oz)	11.3 (0.4)
Bus Capacitance	μF	33
P4 Connector	-	12-port, 1.27 mm spaced header, vertical mount (pin 7 keyed)
P5 Connector	-	14-port, 1.27 mm spaced header, vertical mount
P10 Connector	-	6-port, 2.54 mm spaced fixed screw terminals
P11 Connector	-	12-port, 2.54 mm spaced fixed screw terminals
P12 Connector	-	2-port, 2.54 mm spaced fixed screw terminals

Information on Approvals and Compliances



The RoHS II Directive 2011/65/EU restricts the use of certain substances including lead, mercury, cadmium, hexavalent chromium and halogenated flame retardants PBB and PBDE in electronic equipment.

PIN FUNCTIONS

P4 – Drive Mounting Power / Motor Connector

12-port vertical header for drive insertion – direct connection to the drive. Pin 7 keyed to avoid incorrect drive orientation. For pin functions refer to the drive datasheet.

P5 – Drive Mounting Signal Connector

14-port vertical header for drive insertion – direct connection to the drive. For pin functions refer to the drive datasheet. Note that if using a non-velocity mode drive (12-pin signal connector) two ports will remain open on this connector.

P10 – Power / Motor Connector

Pin	Name	Description / Notes	I/O
1	MOTOR A	Motor Phase Outputs. Current output distributed equally across 2 pins per motor phase, 3A continuous current carrying capacity per pin. For single phase (brushed) motors, set DIP Switch SW1 and SW2 to ON and use only Motor A and Motor B.	O
2	MOTOR B		O
3	MOTOR C		O
4	PWR GND	Power Ground (Common With Signal Ground). 3A Continuous Current Rating Per Pin	GND
5	HV IN	DC Power Input. 3A Continuous Current Rating Per Pin. Requires a minimum of 47 μ F external capacitance between HV IN and PWR GND pins.	I
6	RESERVED	Reserved	-

P11 – I/O Connector

Pin	Name	Description	I/O
1	-REF IN / DIR IN	Analog Input Drives: Differential Reference Input (± 10 V Operating Range, ± 15 V Maximum Input) PWM Input Drives: Direction Input	I
2	+REF IN / PWM IN	Analog Input Drives: Differential Reference Input (± 10 V Operating Range, ± 15 V Maximum Input) PWM Input Drives: Pulse width modulated digital input command	I
3	SIGNAL GND	Signal Ground (Common With Power Ground).	GND
4	FAULT OUT	TTL level (+5 V) output becomes high when power devices are disabled due to at least one of the following conditions: inhibit, invalid Hall state, output short circuit, over voltage, over temperature, power-up reset.	O
5	INHIBIT IN	TTL level (+5 V) inhibit/enable input. Leave open to enable drive. Pull to ground to inhibit drive. Inhibit turns off all power devices.	I
6	CURRENT MONITOR	Current Monitor. Analog output signal proportional to the actual current output. Scaling is 2 A/V. Measure relative to signal ground.	O
7	HALL 3	Single-ended Hall/Commutation Sensor Inputs (+5 V logic level). For single phase (brushed) motors, set DIP Switch SW1 and SW2 to ON and leave all Hall signals open.	I
8	HALL 2		I
9	HALL 1		I
10	+V HALL OUT	Low Power Supply For Hall Sensors (+5 V @ 30 mA). Referenced to signal ground. Short circuit protected.	O
11	SIGNAL GND	Signal Ground (Common With Power Ground).	GND
12	RESERVED	Reserved	-

P12 – Encoder Connector

Pin	Name	Description / Notes	I/O
1	ENC A	Single-ended encoder channel A input. +5 V logic level.	I
2	ENC B	Single-ended encoder channel B input. +5 V logic level.	I

HARDWARE NOTES

DIP Switch Settings

When set to the ON position, DIP Switches SW1 and SW2 internally short Hall 1 and Hall 3, respectively, to ground for use with single phase (brushed) motors. Note that in this configuration, all Hall signal pins should be left open, and only motor phase outputs A and B should be used. Default switch setting is OFF (three phase / brushless motors).

Note: DIP Switches SW3, SW4 are reserved and must be left in the OFF position.

MECHANICAL INFORMATION

P4 – Drive Mounting Power / Motor Connector

Connector Information	12-port, 1.27 mm spaced header, vertical mount
Mating Connector	No mating connector required. Mate directly to drive.

P5 – Drive Mounting Signal Connector

Connector Information	14-port, 1.27 mm spaced header, vertical mount
Mating Connector	No mating connector required. Mate directly to drive.

P10 – Power / Motor Connector

Connector Information	6-port, 2.54 mm spaced fixed screw terminal
-----------------------	---

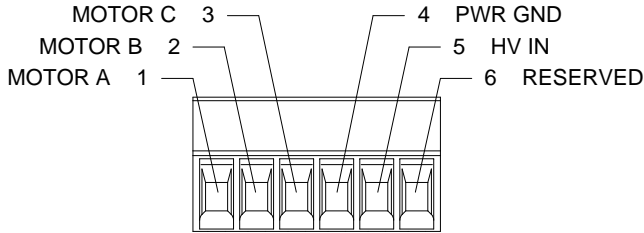

P11 – I/O Connector

Connector Information	12-port, 2.54 mm spaced fixed screw terminal
-----------------------	--

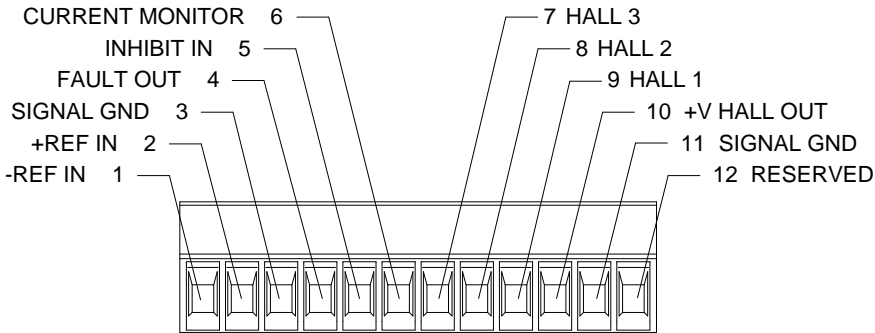

P12 – Encoder Connector

Connector Information	2-port, 2.54 mm spaced fixed screw terminal
-----------------------	---

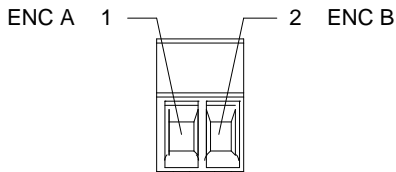

MOUNTING DIMENSIONS

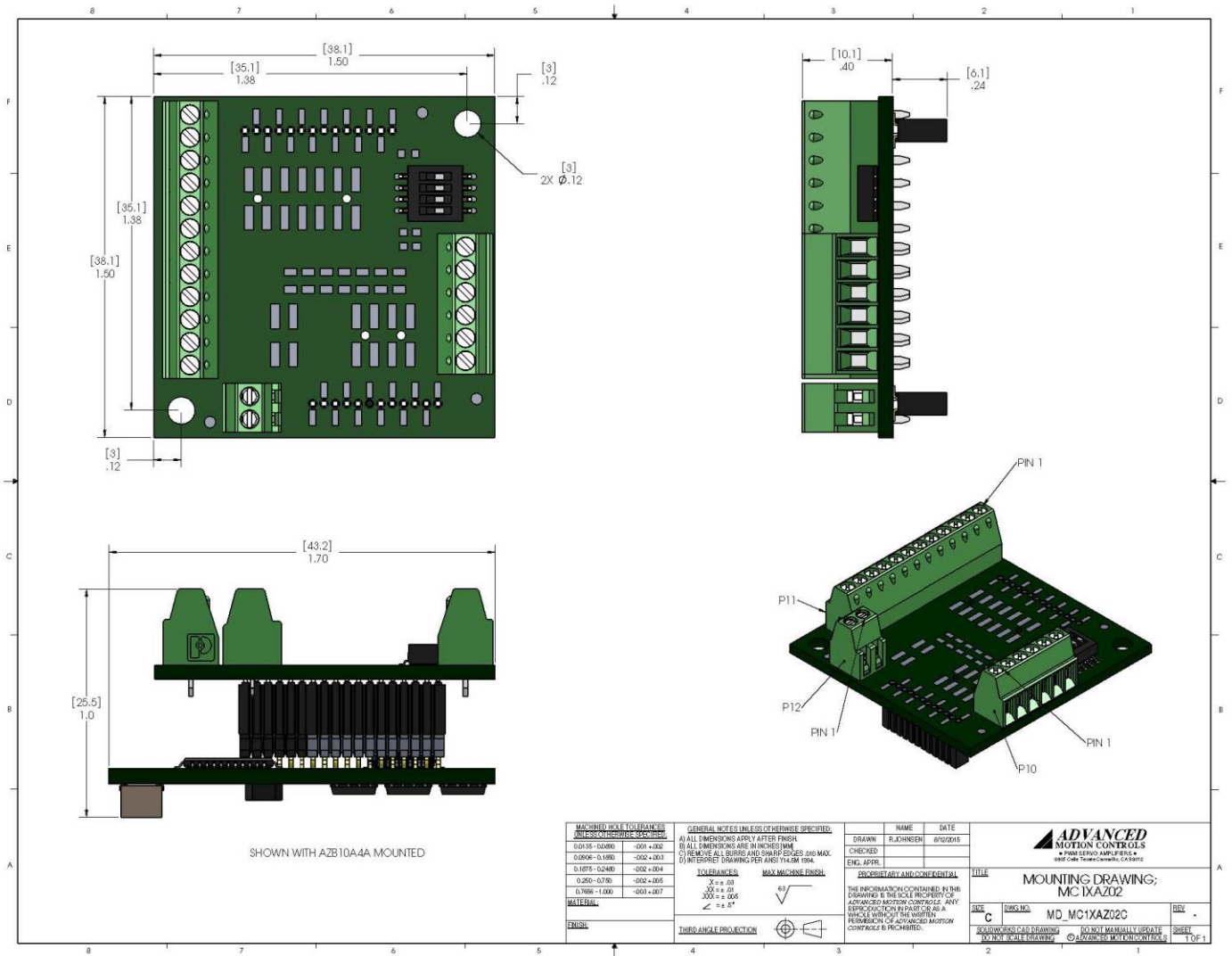

PART NUMBERING INFORMATION

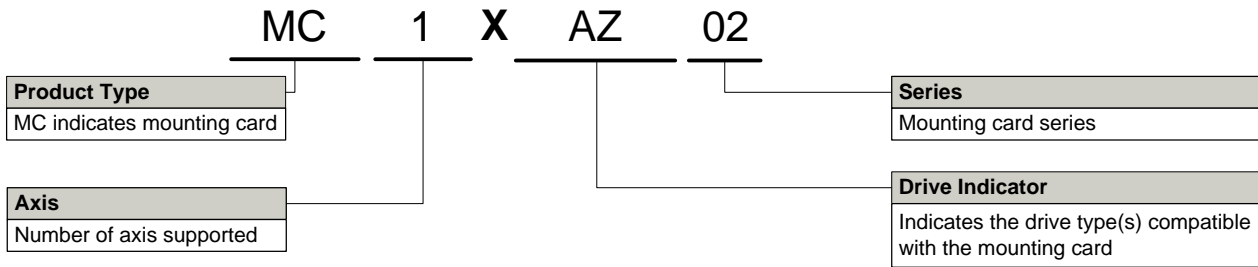

All analog servo drive accessories listed in the selection tables of the website are readily available, standard product offerings. However, additional features and/or options are available for select drives and other possibilities can be made available for OEMs with sufficient volume requests. Feel free to contact Applications Engineering for further information and details.

All specifications in this document are subject to change without written notice. Actual product may differ from pictures provided in this document.