

Description

The B30A40AC PWM servo drive is designed to drive brushless DC motors at a high switching frequency. A single red/green LED indicates operating status. The drive is fully protected against over-voltage, under voltage, over-current, over-heating and short-circuits across motor, ground and power leads. Furthermore, the drive can interface with digital controllers or be used stand-alone and requires only a single unregulated AC power supply. Loop gain, current limit, input gain and offset can be adjusted using 14-turn potentiometers. The offset adjusting potentiometer can also be used as an on-board input signal for testing purposes.

See Part Numbering Information on last page of datasheet for additional ordering options. The hardware installation manual for the analog drive family is available for download at www.a-m-c.com.

Power Range

Peak Current	30 A
Continuous Current	15 A
Supply Voltage	45 - 265 VAC



Features

- ▲ Four Quadrant Regenerative Operation
- ▲ Adjustable Current Limits
- ▲ Selectable Inhibit/Enable Logic
- ▲ Built in Shunt Regulator Circuit
- ▲ External Shunt Resistor Terminals
- ▲ On-Board Test Potentiometer
- ▲ Offset Adjustment Potentiometer
- ▲ Selectable 120/60 Hall Commutation Phasing
- ▲ Hall Velocity Mode
- ▲ Encoder Velocity Mode
- ▲ Differential Encoder Feedback
- ▲ Directional Inhibit Inputs for Limit Switches
- ▲ Built-in brake/shunt regulator
- ▲ Internal brake/shunt resistor

MODES OF OPERATION

- Current
- Duty Cycle (Open Loop)
- Hall Velocity
- Velocity

COMMAND SOURCE

- ±10 V Analog

FEEDBACK SUPPORTED

- Halls
- Incremental Encoder
- Tachometer (±60 VDC)

COMPLIANCES & AGENCY APPROVALS

- UL
- cUL
- CE Class A (LVD)
- CE Class A (EMC)
- RoHS

BLOCK DIAGRAM

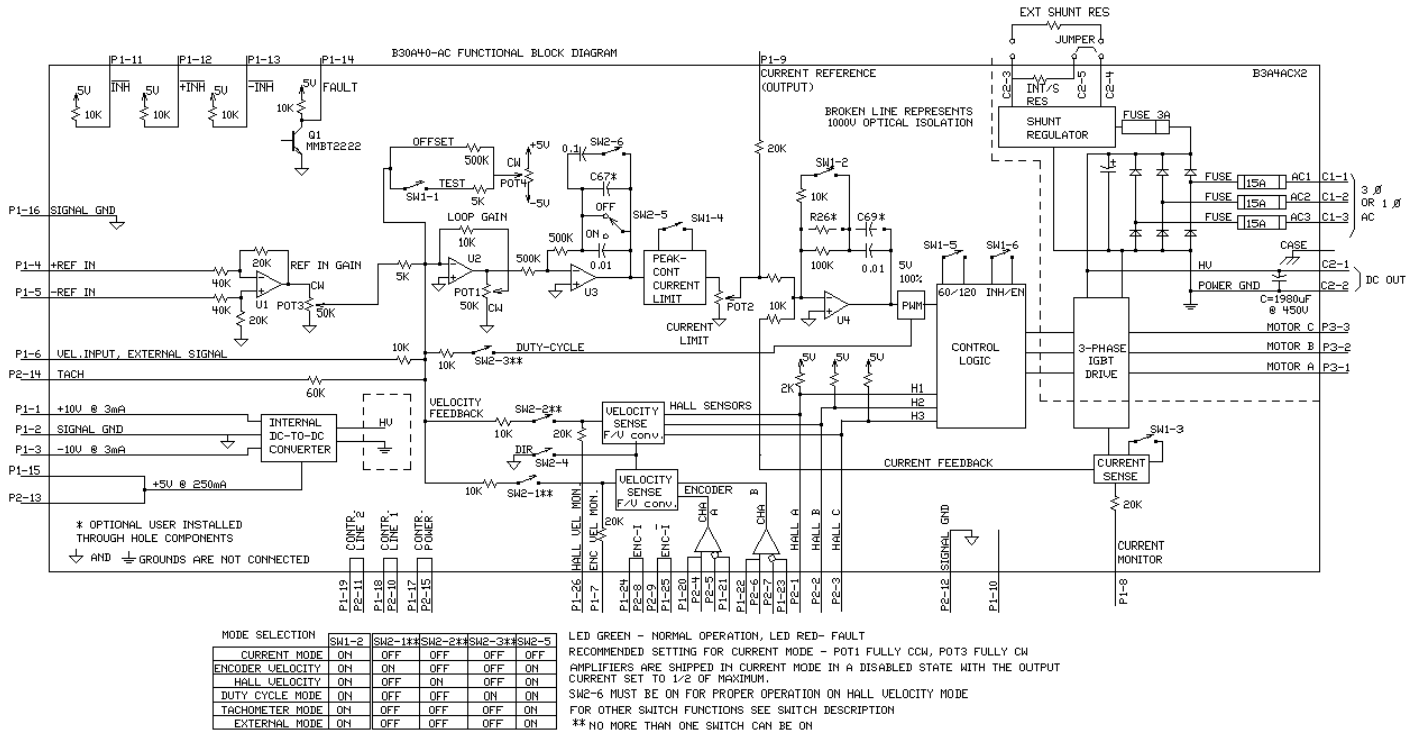

Information on Approvals and Compliances

	<p>US and Canadian safety compliance with UL 508c, the industrial standard for power conversion electronics. UL registered under file number E140173. Note that machine components compliant with UL are considered UL registered as opposed to UL listed as would be the case for commercial products.</p>
	<p>Compliant with European EMC Directive 2014/30/EU on Electromagnetic Compatibility (specifically EN 61000-6-4:2007/A1:2011 for Emissions, Class A and EN 61000-6-2:2005 for Immunity, Performance Criteria A). LVD requirements of Directive 2014/35/EU (specifically, EN 60204-1:2006/A1:2009, a Low Voltage Directive to protect users from electrical shock).</p>
	<p>The RoHS Directive restricts the use of certain substances including lead, mercury, cadmium, hexavalent chromium and halogenated flame retardants PBB and PBDE in electronic equipment.</p>

SPECIFICATIONS

Power Specifications		
Description	Units	Value
AC Supply Voltage Range	VAC	45 - 265
AC Input Phases ¹	-	3
DC Supply Voltage Range	VDC	60 - 400
DC Bus Over Voltage Limit	VDC	425
Maximum Peak Output Current ²	A	30
Maximum Continuous Output Current	A	15
Maximum Continuous Output Power	W	5700
Maximum Power Dissipation at Continuous Current	W	300
Internal Bus Capacitance	µF	1980
Internal Shunt Resistance	Ω	30
Internal Shunt Resistor Power Rating	W	50
Internal Shunt Resistor Turn-on Voltage	VDC	390
Minimum Load Inductance (Line-To-Line) ³	µH	600
Low Voltage Supply Outputs	-	±10 VDC (3 mA), +5 VDC (250 mA)
Switching Frequency	kHz	20
Shunt Fuse	A	3
Bus Fuse	A	15
Control Specifications		
Description	Units	Value
Command Sources	-	±10 V Analog
Feedback Supported	-	Halls, Incremental Encoder, Tachometer (±60 VDC)
Commutation Methods	-	Trapezoidal
Modes of Operation	-	Current, Hall Velocity, Duty Cycle, Velocity
Motors Supported	-	Single Phase (Brushed, Voice Coil, Inductive Load), Three Phase (Brushless)
Hardware Protection	-	Invalid Commutation Feedback, Over Current, Over Temperature, Over Voltage, Short Circuit (Phase-Phase & Phase-Ground)
Primary I/O Logic Level	-	5V TTL
Internal Shunt Regulator	-	Yes
Internal Shunt Resistor	-	Yes
Mechanical Specifications		
Description	Units	Value
Agency Approvals	-	CE Class A (EMC), CE Class A (LVD), cUL, RoHS, UL
Size (H x W x D)	mm (in)	203.2 x 165.7 x 103.1 (8 x 6.5 x 4.1)
Weight	g (oz)	2230 (78.7)
Heatsink (Base) Temperature Range ⁴	°C (°F)	0 - 65 (32 - 149)
Storage Temperature Range	°C (°F)	-40 - 85 (-40 - 185)
Form Factor	-	Panel Mount
C1 Connector	-	5-contact, 11.10 mm spaced, tri-barrier terminal block
C2 Connector	-	5-contact, 11.10 mm spaced, tri-barrier terminal block
P1 Connector	-	26-pin, high-density, female D-sub
P2 Connector	-	15-pin, high-density, female D-sub
P3 Connector	-	3-contact, 11.10 mm spaced, dual-barrier terminal block

Notes

1. Can operate on single-phase VAC if peak/cont. current ratings are reduced by at least 30%.
2. Maximum duration of peak current is ~2 seconds. Peak RMS value must not exceed continuous current rating of the drive.
3. Lower inductance is acceptable for bus voltages well below maximum. Use external inductance to meet requirements.
4. Additional cooling and/or heatsink may be required to achieve rated performance.

PIN FUNCTIONS

C1 - Power Connector			
Pin	Name	Description / Notes	I/O
1	AC1	AC Supply Input (Single Or Three Phase)	I
2	AC2		I
3	AC3		I
4	CASE GND	Case Ground	PE
5	NC	Not Connected (Reserved)	-

C2 - Power Connector			
Pin	Name	Description / Notes	I/O
1	HIGH VOLTAGE	DC Bus Output	O
2	POWER GND		PGND
3	EXT SHUNT RES	External Shunt Resistor Connection. Connect resistor between this port and Shunt Resistor DC+.	-
4	SHUNT RES DC+	Shunt Resistor DC+. Connection for shunt resistor.	-
5	INT SHUNT RES	Internal Shunt Resistor. Jumper to Shunt Resistor DC+ to activate.	-

P1 - Signal Connector			
Pin	Name	Description / Notes	I/O
1	+10V 3mA OUT	±10 V @ 3 mA low power supply for customer use. Short circuit protected. Reference ground common with signal ground.	O
2	SIGNAL GND		SGND
3	-10V 3mA OUT		O
4	+REF	Differential Reference Input (±10 V Operating Range, ±15 V Maximum Input)	I
5	-REF		I
6	VEL INPUT	Single ended reference input for external velocity signal, range ±10 V (maximum ±15 V).	I
7	ENC. VEL. MONITOR	Encoder Velocity Monitor. Analog output proportional to the frequency of encoder lines or, equivalently, to motor speed. Scaling is 25 kHz/V.	O
8	CURR MONITOR OUT	Current Monitor. Analog output signal proportional to the actual current output. Polarity is reversed from command voltage. Scaling is 4.2 A/V by default but may be reduced to half this value by setting DIP switch SW1-3 to OFF (see Hardware Settings section below). Measure relative to signal ground.	O
9	CURR REFERENCE	Measures the command signal to the internal current-loop. This pin has a maximum output of ±7.25 V when the drive outputs maximum peak current. Measure relative to signal ground.	O
10	RESERVED	Reserved	-
11	INHIBIT / ENABLE	TTL level (+5 V) inhibit/enable input. Pull to ground to inhibit drive (SW1-6 ON). Pull to ground to enable drive (SW1-6 OFF).	I
12	+INHIBIT / ENABLE	Positive Direction Inhibit (Does Not Cause A Fault Condition)	I
13	-INHIBIT / ENABLE	Negative Direction Inhibit (Does Not Cause A Fault Condition)	I
14	FAULT	TTL level (+5 V) output becomes high when power devices are disabled due to at least one of the following conditions: inhibit, invalid Hall state, output short circuit, over voltage, over temperature, power-up reset.	O
15	+5V @ 250mA	±5 V @ 250 mA low power supply for customer use. Short circuit protected. Referenced to signal ground.	O
16	SIGNAL GND	Signal Ground	SGND
17	CTLR. POWER	Controller Power. Pass-through to Port 2 (P2) for customer use.	I/O
18	CTLR. LINE 1	User Controller Signal. Pass-through to Port 2 (P2) for customer use.	I/O
19	CTLR. LINE 2		I/O
20	ENC. CH. A+		O
21	ENC. CH. A-	Differential Encoder Channel A Output. Pass-through from Port 2 (P2).	O
22	ENC. CH. B+	Differential Encoder Channel B Output. Pass-through from Port 2 (P2).	O
23	ENC. CH. B-		O
24	ENC. CH. INDEX+	Differential Encoder Index Output. Pass-through from Port 2 (P2).	O
25	ENC. CH. INDEX-		O
26	HALL VEL. MONITOR	Hall Velocity Monitor. Analog output proportional to the Hall frequency or, equivalently, to motor speed. Scaling is 95 Hz/V.	O

P2 - Feedback Connector			
Pin	Name	Description / Notes	I/O
1	HALL A	Single-ended Hall/Commutation Sensor Inputs (+5 V logic level)	I
2	HALL B		I
3	HALL C		I
4	ENC. CH. A+	Differential Encoder Channel A Input (+5 V Logic Level)	I
5	ENC. CH. A-		I
6	ENC. CH. B+	Differential Encoder Channel B Input (+5 V Logic Level)	I
7	ENC. CH. B-		I
8	ENC. CH. INDEX+	Differential Encoder Index Input (+5 V Logic Level)	I
9	ENC. CH. INDEX-		I
10	CTRL. LINE 1	User Controller Signal. Pass-through to Port 1 (P1) for customer use.	I/O
11	CTRL. LINE 2		I/O
12	SIGNAL GND	Signal Ground	SGND
13	+5V @ 250mA	±5 V @ 250 mA low power supply for customer use. Short circuit protected. Referenced to signal ground.	O
14	TACH IN	Negative Tachometer Input (Maximum ±60 V). Use signal ground for positive input.	I
15	CTRL. POWER	Controller Power. Pass-through to Port 1 (P1) for customer use.	I/O

P3 - Motor Power Connector			
Pin	Name	Description / Notes	I/O
1	MOTOR A	Motor Phase A	O
2	MOTOR B	Motor Phase B	O
3	MOTOR C	Motor Phase C	O

HARDWARE SETTINGS

Switch Functions

SW1				
Switch	Description	Setting		
		On	Off	
1	Test/Offset. Switches the function of the Test/Offset pot between an on-board command input for testing or a command offset adjustment. OFF by default.	Test	Offset	
2	Current loop proportional gain adjustment. ON by default.	Decrease	Increase	
3	Current scaling. When OFF, increases sensitivity of current sense thus reducing both peak and continuous current limit by 50%. The scaling of the current monitor output signal becomes ½ its ordinary value when this switch is OFF.	Full-current	Half-current	
4	Current ratio. Used to set continuous-to-peak current ratio. Default is ON.	Cont./Peak Ratio = 50%	Cont./Peak Ratio = 25%	
5	Hall sensor phasing. Selects 120°/60° commutation phasing. ON by default.	120°	60°	
6	Inhibit logic. Sets the logic level of inhibit pins.	Active Low	Active High	

SW2				
Switch	Description	Setting		
		On	Off	
1	Mode selection. See mode selection table below.	-	-	
2	Mode selection. See mode selection table below.	-	-	
3	Mode selection. See mode selection table below.	-	-	
4	Velocity feedback polarity. Changes the polarity of the internal feedback signal and the velocity monitor output signal. Inversion of the feedback polarity may be required to prevent a motor run-away condition.	Standard	Inverted	
5	Outer loop integration. Activates or deactivates integration. OFF, by default, for current mode and ON for other modes.	Active	Inactive	
6	Outer loop integral gain adjustment. It is recommended to leave this switch OFF for most applications, but ON for Hall Velocity Mode.	Decrease	Increase	

Mode Selection Table

	SW2-1	SW2-2	SW2-3	SW2-5	Encoder	Tachometer
CURRENT	OFF	OFF	OFF	OFF	Not Connected	Not Connected
DUTY CYCLE	OFF	OFF	ON	ON	Not Connected	Not Connected
HALL VELOCITY*	OFF	ON	OFF	ON	Not Connected	Not Connected
ENCODER VELOCITY*	ON	OFF	OFF	ON	Connected	Not Connected
TACHOMETER VELOCITY	OFF	OFF	OFF	ON	Not Connected	Connected
EXTERNAL VELOCITY	OFF	OFF	OFF	ON	Not Connected	Not Connected

*NOTE: See details of switch SW2-4 for further Hall/Encoder Velocity configuration information.

Potentiometer Functions

Potentiometer	Description	Turning CW
1	Loop gain adjustment for duty cycle / velocity modes. Turn this pot fully CCW in current mode.	Increases gain
2	Current limit. It adjusts both continuous and peak current limit while maintaining their ratio.	Increases limit
3	Reference gain. Adjusts the ratio between input signal and output variables (voltage, current, or velocity).	Increases gain
4	Offset / Test. Used to adjust any imbalance in the input signal or in the amplifier. Can also be used as an on-board signal source for testing purposes.	Adjusts offset in negative direction

Note: Potentiometers are approximately linear and have 12 active turns with 1 inactive turn on each end.

Through-hole Components[†]

Location	Description
C67*	Velocity Loop Integrator. Through-hole capacitor that can be added for more precise velocity loop tuning. See section below on Tuning with Through-hole components for more details.
C69*	Current Loop Integrator. Through-hole capacitor that can be added for more precise current loop tuning. See section below on Tuning with Through-hole components for more details.
R26*	Current Loop Proportional Gain. Through-hole resistor that can be added for more precise current loop tuning. See section below on Tuning with Through-hole components for more details.

Tuning With Through-hole Components

In general, the drive will not need to be further tuned with through-hole components. However, for applications requiring more precise tuning than what is offered by the potentiometers and dipswitches, the drive can be manually modified with through-hole resistors and capacitors as denoted in the above table. By default, the through-hole locations are not populated when the drive is shipped. Before attempting to add through-hole components to the board, consult the section on loop tuning in the installation notes on the manufacturer's website. Some general rules of thumb to follow when adding through-hole components are:

- A larger resistor value will increase the proportional gain, and therefore create a faster response time.
- A larger capacitor value will increase the integration time, and therefore create a slower response time.

Proper tuning using the through-hole components will require careful observation of the loop response on a digital oscilloscope to find the optimal through-hole component values for the specific application.

[†]Note: Damage done to the drive while performing these modifications will void the warranty.

MECHANICAL INFORMATION

C1 - Power Connector

Connector Information		5-contact, 11.10 mm spaced, tri-barrier terminal block
Mating Connector	Details	Not applicable
	Included with Drive	Not applicable

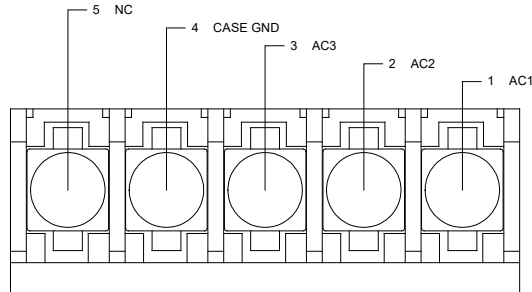

C2 - Power Connector

Connector Information		5-contact, 11.10 mm spaced, tri-barrier terminal block
Mating Connector	Details	Not applicable
	Included with Drive	Not applicable

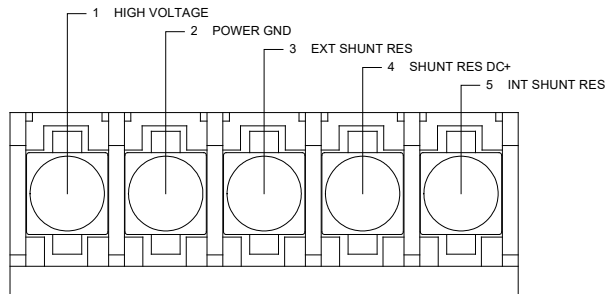

P1 - Signal Connector

Connector Information		26-pin, high-density, female D-sub
Mating Connector	Details	TYCO: Plug P/N 1658671-1; Housing P/N 5748677-2; Terminals P/N 1658670-2 (loose) or 1658670-1 (strip)
	Included with Drive	No

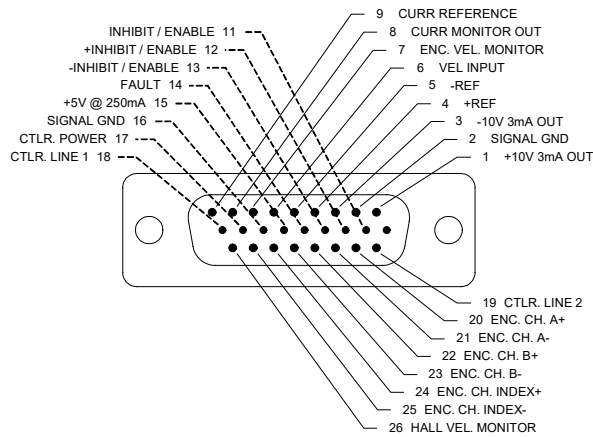

P2 - Feedback Connector

Connector Information		15-pin, high-density, female D-sub
Mating Connector	Details	TYCO: Plug P/N 748364-1; Housing P/N 5748677-1; Terminals P/N 1658670-2 (loose) or 1658670-1 (strip)
	Included with Drive	No

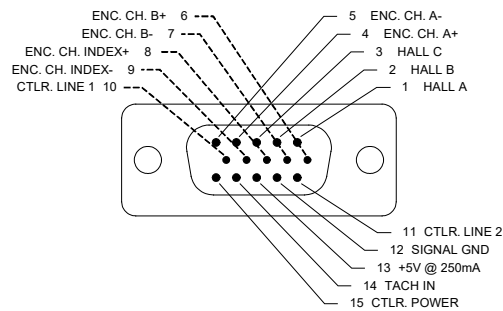

P3 - Motor Power Connector

Connector Information		3-contact, 11.10 mm spaced, dual-barrier terminal block
Mating Connector	Details	Not applicable
	Included with Drive	Not applicable

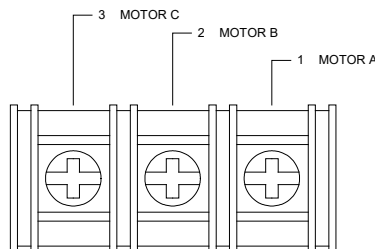

MOUNTING DIMENSIONS

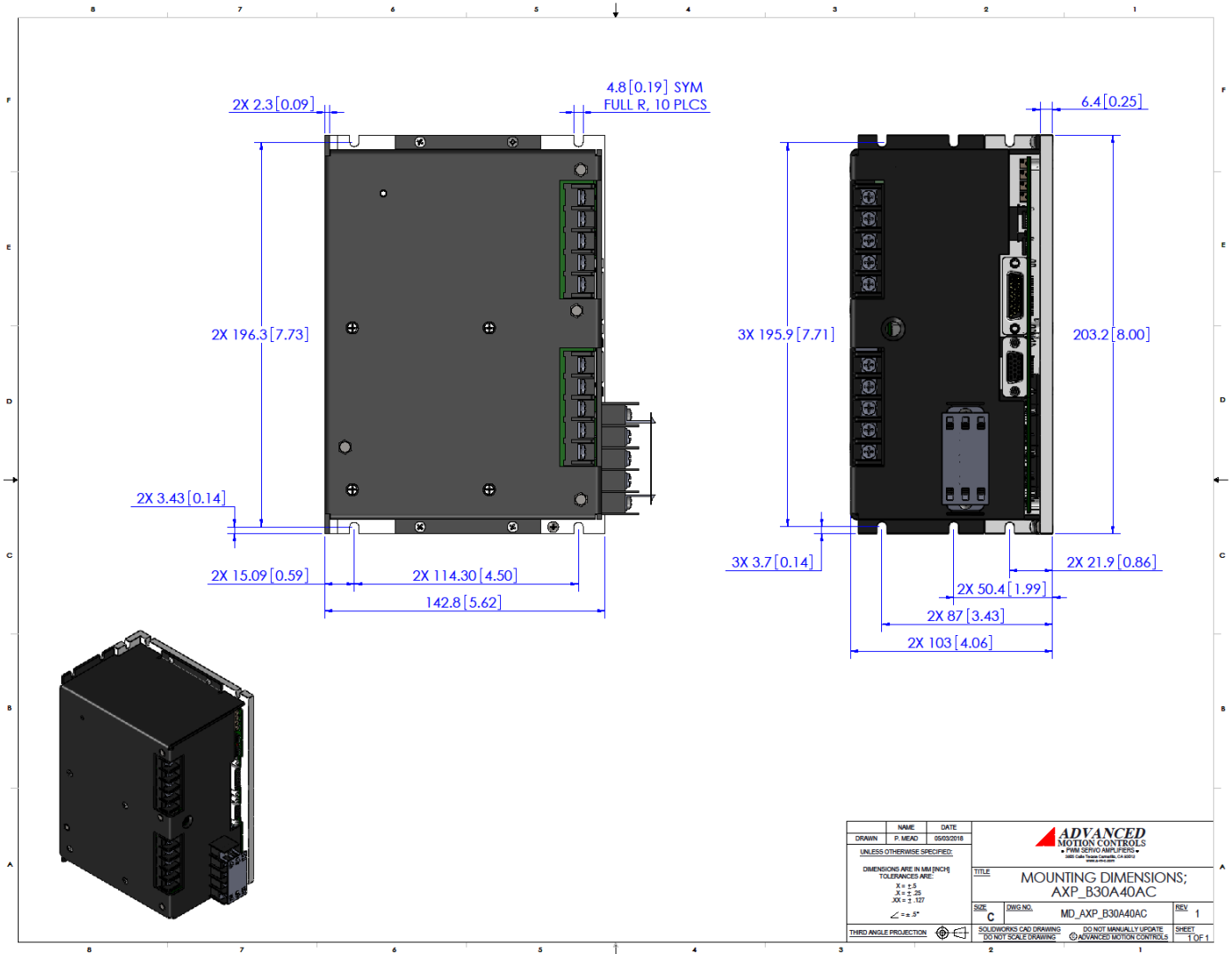

PART NUMBERING INFORMATION

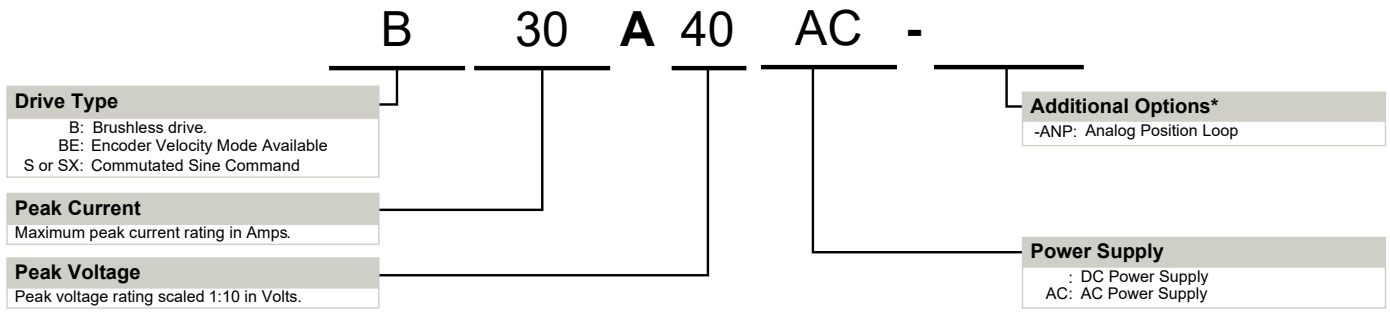

* Options available for orders with sufficient volume. Contact *ADVANCED* Motion Controls for more information.

ADVANCED Motion Controls analog series of servo drives are available in many configurations. Note that not all possible part number combinations are offered as standard drives. All models listed in the selection tables of the website are readily available, standard product offerings.

ADVANCED Motion Controls also has the capability to promptly develop and deliver specified products for OEMs with volume requests. Our Applications and Engineering Departments will work closely with your design team through all stages of development in order to provide the best servo drive solution for your system. Equipped with on-site manufacturing for quick-turn customs capabilities, *ADVANCED* Motion Controls utilizes our years of engineering and manufacturing expertise to decrease your costs and time-to-market while increasing system quality and reliability.

Examples of Modifications and Customized Products

- ▲ Integration of Drive into Motor Housing
- ▲ Mount OEM PCB onto Drive Without Cables
- ▲ Multi-axis Configuration for Compact System
- ▲ Custom PCB and Baseplate for Optimized Footprint
- ▲ RTV/Epoxy Components for High Vibration
- ▲ OEM Specified Connectors for Instant Compatibility
- ▲ OEM Specified Silkscreen for Custom Appearance
- ▲ Increased Thermal Limits for High Temp. Operation
- ▲ Integrate OEM Circuitry onto Drive PCB
- ▲ Custom Control Loop Tuned to Motor Characteristics
- ▲ Custom I/O Interface for System Compatibility
- ▲ Preset Switches and Pots to Reduce User Setup
- ▲ Optimized Switching Frequency
- ▲ Ramped Velocity Command for Smooth Acceleration
- ▲ Remove Unused Features to Reduce OEM Cost
- ▲ Application Specific Current and Voltage Limits

Feel free to contact Applications Engineering for further information and details.

Available Accessories

ADVANCED Motion Controls offers a variety of accessories designed to facilitate drive integration into a servo system. Visit www.a-m-c.com to see which accessories will assist with your application design and implementation.



To Motor

All specifications in this document are subject to change without written notice. Actual product may differ from pictures provided in this document.