

Description

The DZCANTU-020B080 digital servo drive is designed to drive brushed and brushless servomotors, stepper motors, and AC induction motors from a compact form factor ideal for embedded applications. This fully digital drive operates in torque, velocity, or position mode and employs Space Vector Modulation (SVM), which results in higher bus voltage utilization and reduced heat dissipation compared to traditional PWM. The drive can be configured for a variety of external command signals. Commands can also be configured using the drive's built-in Motion Engine, an internal motion controller used with distributed motion applications. In addition to motor control, this drive features dedicated and programmable digital and analog inputs and outputs to enhance interfacing with external controllers and devices.

The DZCANTU-020B080 features a CANopen interface for networking, and a USB interface for drive configuration and setup. Drive commissioning is accomplished using DriveWare® 7, available for download at www.a-m-c.com.

The DZCANTU Hardware Installation Manual is available for download from www.a-m-c.com. All drive and motor parameters are stored in non-volatile memory.

Power Range

Peak Current	20 A (14.1 A _{RMS})
Continuous Current	10 A (10 A _{RMS})
Supply Voltage	18 - 80 VDC



Features

- ▲ Follows the CAN in Automation (CiA) 301 Communications Profile and 402 Device Profile
- ▲ Four Quadrant Regenerative Operation
- ▲ Space Vector Modulation (SVM) Technology
- ▲ Fully Digital State-of-the-art Design
- ▲ Programmable Gain Settings
- ▲ Fully Configurable Current, Voltage, Velocity and Position Limits
- ▲ PIDF Velocity Loop
- ▲ PID + FF Position Loop
- ▲ Compact Size, High Power Density
- ▲ 12-bit Analog to Digital Hardware
- ▲ On-the-Fly Mode Switching
- ▲ On-the-Fly Gain Set Switching
- ▲ Dedicated Safe Torque Off (STO) Inputs

MODES OF OPERATION

- Profile Modes
- Cyclic Synchronous Modes
- Current
- Velocity
- Position
- Interpolated Position Mode (PVT)

COMMAND SOURCE

- ±10 V Analog
- Encoder Following
- Over the Network
- Sequencing
- Indexing
- Jogging

FEEDBACK SUPPORTED (FIRMWARE DEPENDENT)

- Halls
- Incremental Encoder
- Auxiliary Incremental Encoder
- 1Vp-p Sine/Cosine Encoder
- Absolute Encoder (EnDat® 2.1/2.2, Hiperface®, or BiSS C-Mode)
- ±10 VDC Position
- Tachometer (±10 VDC)

INPUTS/OUTPUTS

- 1 Programmable Analog Input (12-bit Resolution)
- 5 Programmable Digital Inputs (Differential)
- 3 Programmable Digital Inputs (Single-Ended)
- 5 Programmable Digital Outputs (Single-Ended)
- 3 High Speed Captures



COMPLIANCES & AGENCY APPROVALS

- RoHS
- TÜV Rheinland® (STO)
- CE Class A (LVD)
- CE Class A (EMC)
- UL/cUL Pending

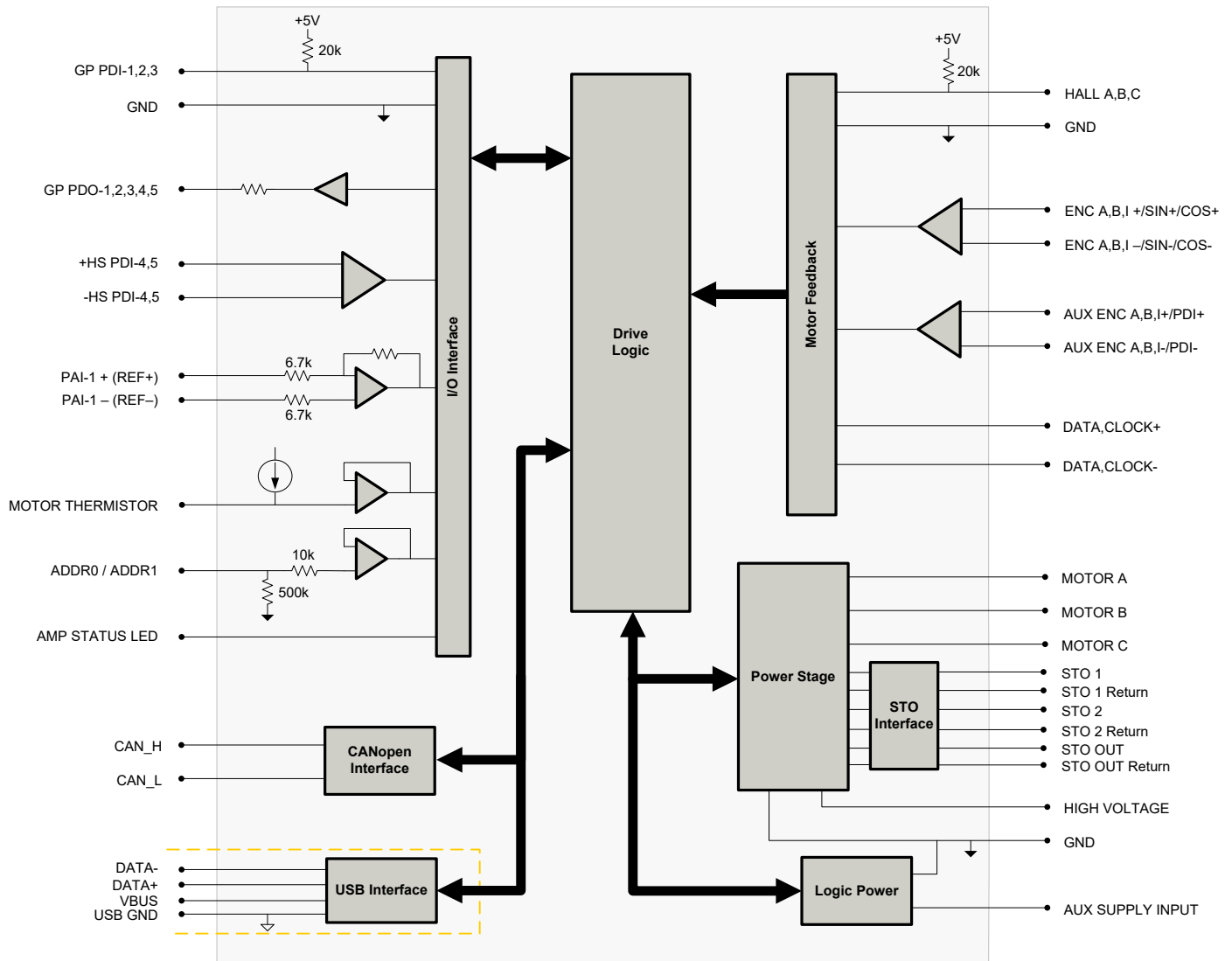
BLOCK DIAGRAM



Information on Approvals and Compliances

	<p>Compliant with European EMC Directive 2014/30/EU on Electromagnetic Compatibility (specifically EN 61000-6-4:2007/A1:2011 for Emissions, Class A and EN 61000-6-2:2005 for Immunity, Performance Criteria A). LVD requirements of Directive 2014/35/EU (specifically, EN 60204-1:2006/A1:2009, a Low Voltage Directive to protect users from electrical shock).</p>
	<p>The RoHS Directive restricts the use of certain substances including lead, mercury, cadmium, hexavalent chromium and halogenated flame retardants PBB and PBDE in electronic equipment.</p>
	<p>Functional Safety STO is TÜV Rheinland® certified and meets requirements of the following standards:</p> <ul style="list-style-type: none"> • EN ISO 13849-1 Category 4 / PL e • EN IEC 61800-5-2 STO (SIL 3) • EN62061 SIL CL3 • IEC 61508 SIL 3

SPECIFICATIONS

Power Specifications		
Description	Units	Value
DC Supply Voltage Range	VDC	18 - 80
DC Bus Over Voltage Limit	VDC	89
DC Bus Under Voltage Limit	VDC	16
Logic Supply Voltage	VDC	18 - 80
Safe Torque Off Voltage (Nominal)	VDC	5 (operating active range, 2.5V to 15V)
Maximum Peak Output Current ¹	A (Arms)	20 (14.1)
Maximum Continuous Output Current ²	A (Arms)	10 (10)
Maximum Continuous Output Power	W	760
Maximum Power Dissipation at Continuous Current	W	40
Internal Bus Capacitance ³	µF	33
Minimum Load Inductance (Line-To-Line) ⁴	µH	250 (at 80 V supply); 150 (at 48 V supply); 75 (at 24 V supply)
Switching Frequency	kHz	20
Maximum Output PWM Duty Cycle	%	85
Control Specifications		
Description	Units	Value
Communication Interfaces	-	CANopen (USB for configuration)
Command Sources	-	±10 V Analog, Encoder Following, Over the Network, Indexing, Jogging
Feedback Supported (Firmware Dependent)	-	Auxiliary Incremental Encoder, Halls, Incremental Encoder, 1Vp-p Sine/Cosine Encoder, Absolute Encoder (EnDat® 2.1/2.2, Hiperface®, or BiSS C-Mode), ±10 VDC Position, Tachometer (±10 VDC)
Commutation Methods	-	Sinusoidal, Trapezoidal
Modes of Operation	-	Profile Modes, Cyclic Synchronous Modes, Current, Velocity, Position, Interpolated Position Mode (PVT)
Motors Supported ⁵	-	Three Phase (Brushless Servo), Single Phase (Brushed Servo, Voice Coil, Inductive Load), Stepper (2- or 3-Phase Closed Loop), AC Induction (Closed Loop Vector)
Hardware Protection	-	40+ Configurable Functions, Over Current, Over Temperature (Drive & Motor), Over Voltage, Short Circuit (Phase-Phase & Phase-Ground), Under Voltage
Programmable Digital Inputs/Outputs (PDIs/PDOs)	-	8/5
Programmable Analog Inputs/Outputs (PAIs/PAOs)	-	1/0
Primary I/O Logic Level	-	5V TTL
Current Loop Sample Time	µs	50
Velocity Loop Sample Time	µs	100
Position Loop Sample Time	µs	100
Maximum Encoder Frequency	MHz	20 (5 pre-quadrature)
Mechanical Specifications		
Description	Units	Value
Agency Approvals	-	CE Class A (EMC), CE Class A (LVD), TÜV Rheinland® (STO), RoHS, UL/cUL Pending
Size (H x W x D)	mm (in)	88.9 x 63.5 x 20.1 (3.5 x 2.5 x 0.8)
Weight	g (oz)	124.7 (4.4)
Baseplate Operating Temperature Range ⁶	°C (°F)	0 - 75 (32 - 167)
Storage Temperature Range	°C (°F)	-20 - 85 (-4 - 185)
Relative Humidity	-	0 - 90% non-condensing
Altitude	m (ft)	0 - 4000 (0 - 13123)
Cooling System	-	Natural Convection
Form Factor	-	PCB Mounted
P1 Connector	-	68-pin, 1.27 mm spaced, dual-row header
P2 Connector	-	58-pin, 2.0 mm spaced, dual-row header

Notes

1. Capable of supplying drive rated peak current for 2 seconds with 10 second foldback to continuous value. Longer times are possible with lower current limits.
2. Continuous I_{Arms} value attainable when RMS Charge-Based Limiting is used.
3. Additional 100 µF / 100 V external bus capacitor between High Voltage and Power Ground as close to the drive as possible required.
4. Lower inductance is acceptable for bus voltages well below maximum. Use external inductance to meet requirements.
5. Maximum motor speed for stepper motors is 600 RPM. Consult the hardware installation manual for 2-phase stepper wiring configuration.
6. Additional cooling and/or heatsink may be required to achieve rated performance.

PIN FUNCTIONS

P1 - Signal Connector			
Pin	Name	Description / Notes	I/O
1	RESERVED	Reserved. Do not connect.	-
3	PAI-1-	Differential Programmable Analog Input or Reference Signal Input (12-bit Resolution)	I
5	PAI-1+		I
7	GROUND	Ground	GND
9	MOT ENC B- / COS-	Primary Incremental Encoder or Cos Input from feedback device (Absolute or Sin/Cos 1Vp-p). Leave open for BiSS and EnDat 2.2.	I
11	MOT ENC B+ / COS+		I
13	GROUND	Ground	GND
15	MOTOR THERMISTOR	Motor Thermistor Input	I
17	MOT ENC CLK-	Serial Interface (RS485) for absolute feedback device (BiSS: MA-/+)	I/O
19	MOT ENC CLK+		I/O
21	MOT ENC I-	Differential Incremental Encoder Channel I. Leave open for BiSS and EnDat 2.2.	I
23	MOT ENC I+		I
25	AUX ENC I-	Auxiliary Incremental Encoder Channel I or Differential Programmable Digital Input 8	I
27	AUX ENC I+		I
29	+5V OUT	+5V User Supply (current between P1-14 and P1-29 must not exceed 250 mA)	O
31	HALL C	Single-ended Commutation Sensor Input	I
33	PDI5-	Differential Programmable Digital Input 5 (High Speed Capture)	I
35	PDI5+		I
37	GP PDO-5	General Purpose Programmable Digital Output	O
39	GP PDO-4	General Purpose Programmable Digital Output	O
41	GP PDO-3	General Purpose Programmable Digital Output	O
43	GP PDO-2	General Purpose Programmable Digital Output	O
45	GP PDO-1	General Purpose Programmable Digital Output	O
47	RESERVED	Reserved. Do not connect.	-
49	+5V USB	USB Supply	O
51	GND USB	USB Ground	UGND
53	GROUND	Ground	GND
55	RESERVED	Reserved. Do not connect.	-
57	RESERVED	Reserved. Do not connect.	-
59	GROUND	Ground	GND
61	RESERVED	Reserved. Do not connect.	-
63	RESERVED	Reserved. Do not connect.	-
65	RESERVED	Reserved. Do not connect.	-
67	GROUND	Ground	GND

P1 - Signal Connector			
Pin	Name	Description / Notes	I/O
2	CAN BAUD	CAN Bus Bit Rate Selector	I
4	ADDR1	CAN Bus Address Selector	I
6	ADDR0		I
8	GROUND	Ground	GND
10	MOT ENC A- / SIN-	Primary Incremental Encoder or Sin Input from feedback device (Absolute or Sin/Cos 1Vp-p). Leave open for BiSS and EnDat 2.2.	I
12	MOT ENC A+ / SIN+		I
14	+5V OUT	+5V User Supply (current between P1-14 and P1-29 must not exceed 250 mA)	O
16	GROUND	Ground	GND
18	MOT ENC DATA-	Serial Interface (RS485) for absolute feedback device (BiSS: SLO-/+)	I/O
20	MOT ENC DATA+		I/O
22	AUX ENC B-	Auxiliary Incremental Encoder Channel B or Differential Programmable Digital Input 7	I
24	AUX ENC B+		I
26	AUX ENC A-	Auxiliary Incremental Encoder Channel A or Differential Programmable Digital Input 6	I
28	AUX ENC A+		I
30	HALL B	Single-ended Commutation Sensor Inputs	I
32	HALL A		I
34	PDI4-	Differential Programmable Digital Input 4 (High Speed Capture)	I
36	PDI4+		I
38	GP PDI-3	General Purpose Programmable Digital Input (High Speed Capture)	I
40	GP PDI-2	General Purpose Programmable Digital Input	I
42	GP PDI-1	General Purpose Programmable Digital Input	I
44	AMP STATUS LED-	AMP Status LED Output for Bi-Color LED	O
46	AMP STATUS LED+		O
48	RESERVED	Reserved. Do not connect.	-
50	DATA- USB	USB Data Channel	I/O
52	DATA+ USB		I/O
54	GROUND	Ground	GND
56	CAN_LOW	CAN_L bus line (dominant low)	I/O
58	CAN_HIGH	CAN_H bus line (dominant high)	I/O
60	RESERVED		-
62	RESERVED	Reserved. Do not connect.	-
64	RESERVED		-
66	RESERVED		-
68	GROUND	Ground	GND

P2 - Power Connector			
Pin	Name	Description / Notes	I/O
SAFE1	STO OUT RETURN	Safe Torque Off Output Return	STORETO
SAFE2	STO OUTPUT	Safe Torque Off Output	O
SAFE3	STO-2 RETURN	Safe Torque Off 2 Return	STORET2
SAFE4	STO-2	Safe Torque Off – Input 2	I
SAFE5	STO-1 RETURN	Safe Torque Off 1 Return	STORET1
SAFE6	STO-1	Safe Torque Off – Input 1	I
SAFE7	NC		-
SAFE8	NC	Not Connected	-
1	AUX SUPPLY INPUT		I
2	AUX SUPPLY INPUT	Auxiliary Supply Input for Logic backup (Optional)	I
3-10	HIGH VOLTAGE	DC Power Input. Additional 100µF / 100V external bus capacitor required between HV and Ground.	I
11	NC		-
12	NC	Not Connected	-
13-20	GROUND	Ground connection for input power	GND
21	NC		-
22	NC	Not Connected	-
23-30	MOTOR A	Motor Phase A. Current output distributed equally across 8 pins per motor phase, 3A continuous current carrying capacity per pin.	O
31	NC		-
32	NC	Not Connected	-
33-40	MOTOR B	Motor Phase B. Current output distributed equally across 8 pins per motor phase, 3A continuous current carrying capacity per pin.	O
41	NC		-
42	NC	Not Connected	-
43-50	MOTOR C	Motor Phase C. Current output distributed equally across 8 pins per motor phase, 3A continuous current carrying capacity per pin.	O

Pin Details
ADDR0 (P1-6); ADDR1 (P1-4)

ADDR0, as well as *ADDR1*, are used for CAN bus addressing. To set the CAN node address of a drive, apply a fixed voltage to the *ADDR0* and *ADDR1* pins to determine the Node ID. *ADDR0* sets the lower 4 bits of the address, and *ADDR1* sets the upper 4 bits of the address. The values for *ADDR0* and *ADDR1* are always integer multiples of 1/5 V within the range 0-3 V. Examples of the voltages required to set certain node ID's are given in the table below. Setting the address to 000 will utilize the address stored in non-volatile memory. Voltages that result in an address above 63 are reserved and should not be used. Addresses above 63 can be set using DriveWare® or network commands.

ADDR1 Voltage (Volts)	ADDR1 Value (Hex)	ADDR0 Voltage (Volts)	ADDR0 Value (Hex)	CAN Address (Node #) (Decimal)
0	0	0	0	Address stored in non-volatile memory
0	0	0.2	1	1
0	0	0.4	2	2
0	0	0.6	3	3
...
0.6	3	2.8	E	62
0.6	3	3	F	63

CAN BAUD (P1-2)

The CAN bitrate is set by applying the appropriate voltage to the *CAN BAUD* pin as given in the table below. Note that higher bit rates are possible when using the value stored in NVM.

CAN BAUD Value (V)	CAN BAUD Tolerance (V)	CAN Bus Bitrate (bits/s)
0	±0.388	Bit rate stored in non-volatile memory
1	±0.388	500k
2	±0.388	250k
3	±0.388	125k

Safe Torque Off (STO) Inputs (P2-SAFE1 to P2-SAFE8)

The Safe Torque Off (STO) Inputs are dedicated +5VDC sinking single-ended inputs.

MECHANICAL INFORMATION

P1 - Signal Connector

Connector Information		68-pin, 1.27mm spaced, dual-row header
Mating Connector	Details	Samtec: CLP-134-02-F-D-BE-A-K (bottom entry); FLE-134-01-G-DV-A-K (top entry)
	Included with Drive	No

P2 - Power Connector

Connector Information		58-pin, 2.0mm spaced, dual-row header
Mating Connector	Details	Samtec: CLT-129-02-F-D-BE-A-K (bottom entry); TLE-129-01-G-DV-A-K (top entry)
	Included with Drive	No

MOUNTING DIMENSIONS

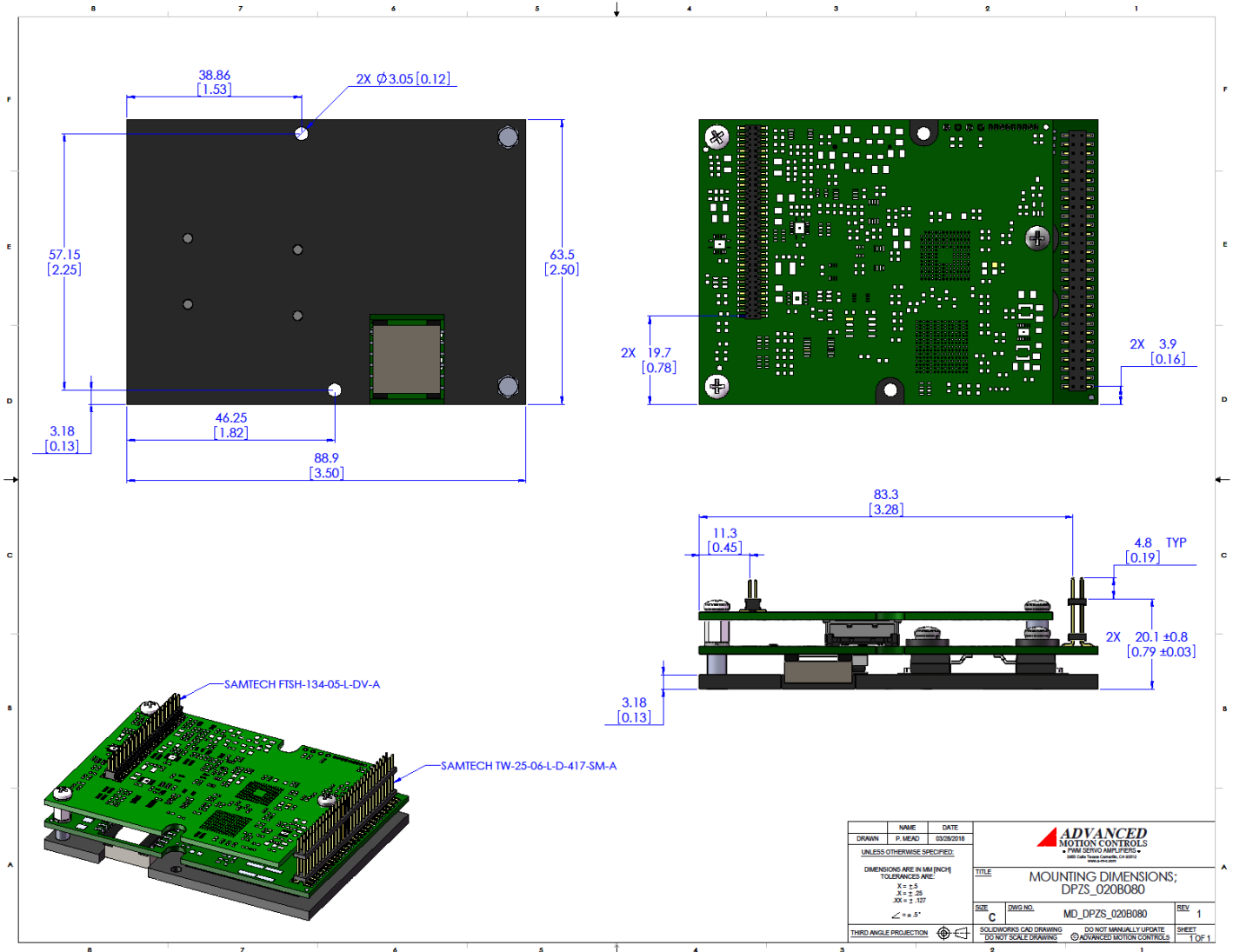

PART NUMBERING INFORMATION

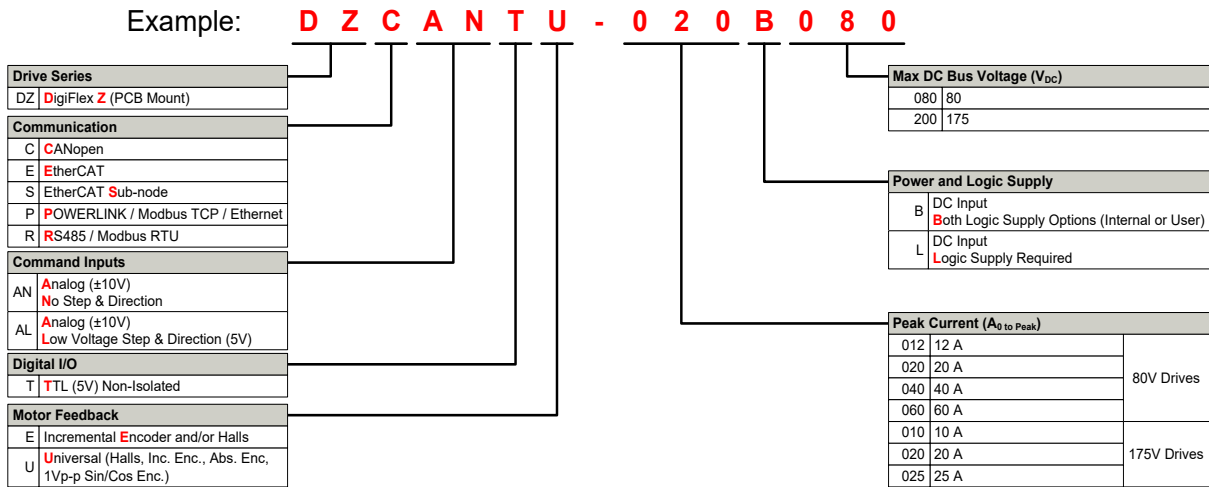

DigiFlex® Performance™ series of products are available in many configurations. Note that not all possible part number combinations are offered as standard drives. All models listed in the selection tables of the website are readily available, standard product offerings.

ADVANCED Motion Controls also has the capability to promptly develop and deliver specified products for OEMs with volume requests. Our Applications and Engineering Departments will work closely with your design team through all stages of development in order to provide the best servo drive solution for your system. Equipped with on-site manufacturing for quick-turn customs capabilities, ADVANCED Motion Controls utilizes our years of engineering and manufacturing expertise to decrease your costs and time-to-market while increasing system quality and reliability.

Examples of Customized Products

- ▲ Optimized Footprint
- ▲ Private Label Software
- ▲ OEM Specified Connectors
- ▲ No Outer Case
- ▲ Increased Current Resolution
- ▲ Increased Temperature Range
- ▲ Custom Control Interface
- ▲ Integrated System I/O
- ▲ Tailored Project File
- ▲ Silkscreen Branding
- ▲ Optimized Base Plate
- ▲ Increased Current Limits
- ▲ Increased Voltage Range
- ▲ Conformal Coating
- ▲ Multi-Axis Configurations
- ▲ Reduced Profile Size and Weight

Feel free to contact Applications Engineering for further information and details.

Available Accessories

ADVANCED Motion Controls offers a variety of accessories designed to facilitate drive integration into a servo system. Visit www.a-m-c.com to see which accessories will assist with your application design and implementation.

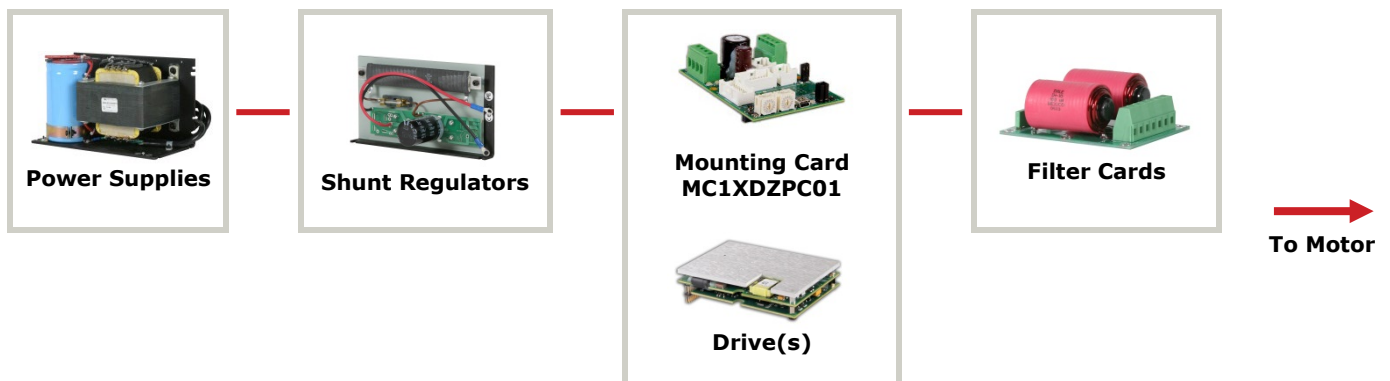

All specifications in this document are subject to change without written notice. Actual product may differ from pictures provided in this document.